

tediselmedical
AN EXPERT INSIGHT INTO HOSPITAL EQUIPMENT



ARES

COMPACT SUSPENDED BRIDGE

COMPACT SUSPENDED BRIDGE



Various ceiling fixation systems (Arms, rotative tube, fixed tube etc.)



Possibility to have vertical tubes with a large variety of accessories



Possibility to install components on the front and rear sides



Colors, HPL, Vinyl, and anodization upon request



Antibacterial paint upon request



Length and specifications upon request



Rounded sides and geometric lines for optimal cleaning



LED lighting (Direct, Indirect and Night Light)

Optimal Space

ARES is our mini ceiling suspended bridge designed to optimize space in critical areas and to cover the main medical needs

ARES is the best option for less invasive procedures which require operative versatility. In critical areas, is the ideal option for limited spaces which require dynamic and efficient support.

- 1 Suspension pipe
- 2 Horizontal unit
- 3 Shelf trolley
- 4 Shelf with drawer for trolley
- 5 Organization of accessories and equipment units

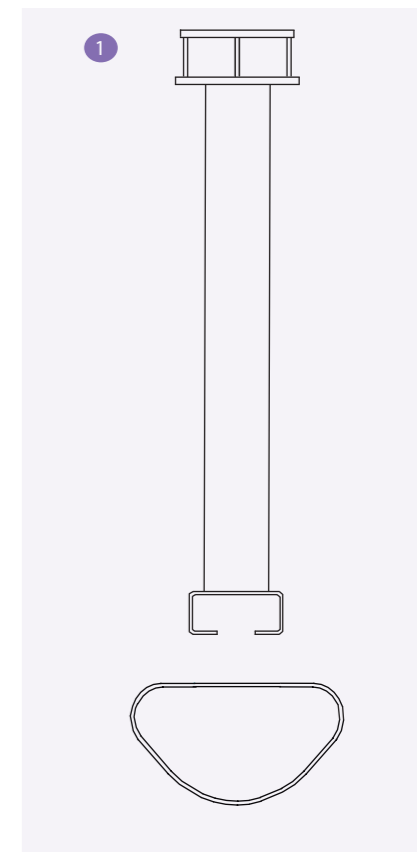

2

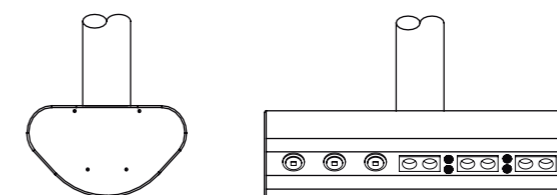

3

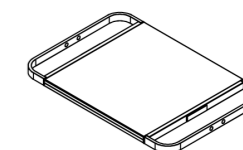

5

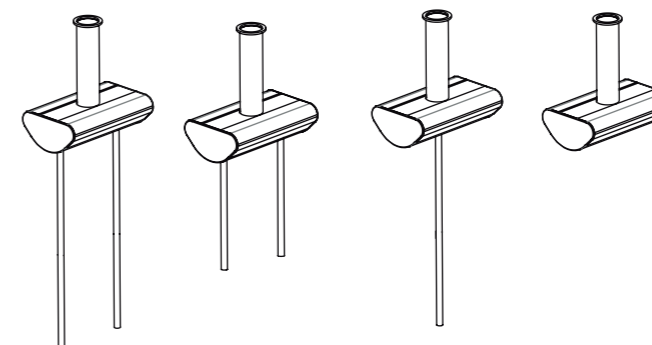

4

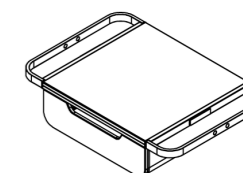

Some references

Hospital de Sant Cugat for ICU	Spain
BGMU Bashkir State Medical University Ufa	Russia
Albertinum Žamberk	Czech Republic
Nemos Maternity SOKOLOV	Czech Republic
Hospital Universitario de Salamanca	Spain
Hospital La Plana Valencia	Spain
Taranto Hospital	Italy
Český Krumlov Hospital	Czech Republic

ARES FIXATIONS

DIRECT CEILING FIXING

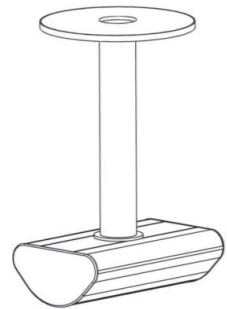

CEILING FIXING WITH ROTATION

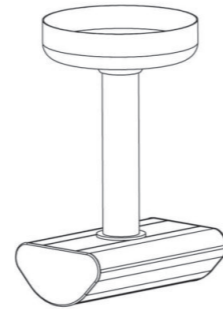

CEILING FIXING WITH SINGLE ARM

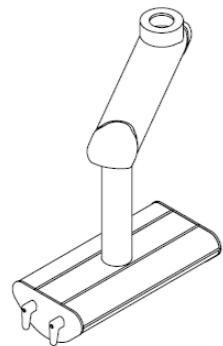

CEILING FIXING WITH DOUBLE ARM

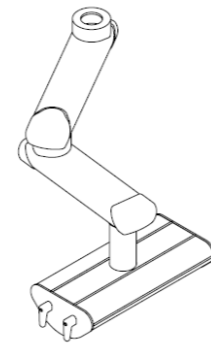

CEILING FIXING WITH SINGLE ARM MOTORIZED

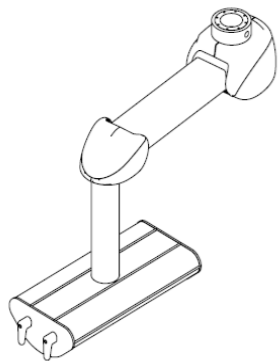

CEILING FIXING WITH DOUBLE ARM MOTORIZED

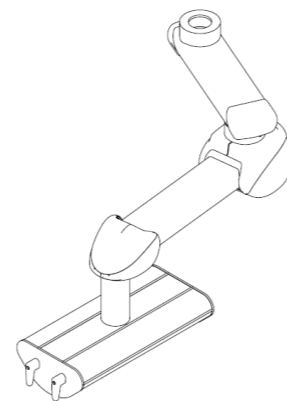

ACCESSORIES

ARES allows multiple configurations and adaptations for the desired installation area. It can integrate vertical poles for the support of various accessories.



Wall Technical rails

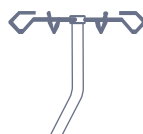

IV Poles & Infusion pumps



Shelves & Drawers



Monitor Support Arms



Examination lamps



Medical baskets and more



Vertical Tubes

QUALITY

Tedisel Management System and all our products are certified with quality seal ISO 13485 and CE marking granted by notified body TÜV RHEINLAND LGA Products GmbH. Tedisel, as a medical device manufacturer, has the medical device manufacturer license number 6205-PS, granted by the Spanish Agency for Medicines and Health Products. All medical devices

developed and manufactured in Tedisel, are regulated by the European Directive 93/42/EEC. All equipment has accreditation and certification of electrical safety and electromagnetic compatibility standards ISO 11197 and EN 60601.

Tedisel Iberica S. L.
Sant LLuc, 69-81
08918 Badalona, BARCELONA, Spain
Tel. +34 93 399 20 58
info@tedisel.com
tediselmedical.com



INF-313-EN

05/2024